

# ***Wireless Microphone Package***

---

## **Operating Instructions**

Before operating the unit, please read this manual thoroughly and retain it for future reference.

**UWP-C1/C2  
UWP-S1/S2  
UWP-X1/X2**



# Table of Contents

<b>Configuration of the Packages</b> .....	<b>4</b>
UWP-C1 .....	4
UWP-C2 .....	5
UWP-S1 .....	6
UWP-S2 .....	7
UWP-X1 .....	8
UWP-X2 .....	9
<b>Features</b> .....	<b>10</b>
<b>Precautions</b> .....	<b>12</b>
<b>Parts Identification</b> .....	<b>13</b>
Body-pack transmitter (UTX-B1) .....	13
Hand-held microphone (UTX-H1) .....	14
Portable diversity tuner (URX-P1) .....	15
Half-rack size diversity tuner (URX-R1) .....	17
Diversity tuner module (URX-M1) .....	18
<b>Power Supply</b> .....	<b>20</b>
Inserting the batteries .....	20
<b>Attachment and Installation Procedures</b> .....	<b>23</b>
Attaching the supplied accessories to the body-pack transmitter (UTX-B1) .....	23
Attaching the supplied accessory to the hand-held microphone (UTX-H1) .....	24
Attaching the supplied accessories to the portable diversity tuner (URX-P1) .....	24
Installing the diversity tuner module (URX-M1) .....	25
<b>Settings</b> .....	<b>28</b>
Setting the transmission channel .....	28
Setting the reception channel ...	29
Detecting and selecting the available channels automatically (diversity tuner module (URX-M1) only) .....	30
Setting the attenuation level of the audio input .....	31
Resetting the accumulated battery use time indication .....	32
Setting the RF output level .....	32
Setting the monitor level (portable diversity tuner (URX-P1) only) .....	33
<b>Operation</b> .....	<b>34</b>
<b>System Configurations</b> .....	<b>35</b>
<b>Error Messages</b> .....	<b>38</b>
<b>Troubleshooting</b> .....	<b>39</b>
<b>Specifications</b> .....	<b>41</b>
<b>Appendix</b> .....	<b>45</b>
Wireless microphone system frequency list .....	45
AC adapter for use with the URX-R1 .....	47

# Configuration of the Packages

This operation manual is for the UWP-C1/C2/S1/S2/X1/X2 wireless microphone packages. The contents of each package are described below.

## UWP-C1

The UWP-C1 consists of a body-pack transmitter (UTX-B1) and a portable diversity tuner (URX-P1). When used in conjunction with a compact camcorder, the UWP-C1 makes a mobile system for ENG (Electronic News Gathering) or EFP (Electronic Field Production) purposes.

### Body-pack transmitter (UTX-B1) (1)

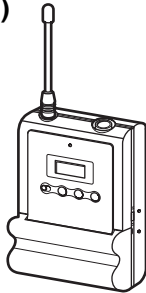

### Portable diversity tuner (URX-P1) (1)

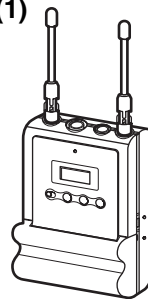

### Supplied accessories

- Omni-directional lavalier microphone (1)
- Wind screen (1)
- Holder clip (1)
- XLR-BMP conversion cable (for use with the URX-P1 only) (1)
- Shoe mount adapter (1)
- Belt clip (2)
- Stereo mini plug-BMP conversion cable (for use with the URX-P1 only) (1)
- Microphone stand adapter (1)
- Operation manual (1)

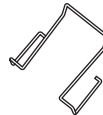
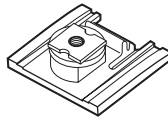
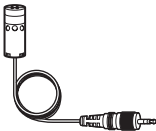

## UWP-C2

The UWP-C2 consists of a hand-held microphone (UTX-H1) and a portable diversity tuner (URX-P1). When used in conjunction with a compact camcorder, the UWP-C2 makes a mobile system for ENG (Electronic News Gathering) or EFP (Electronic Field Production) purposes.

### Hand-held microphone (UTX-H1) (1)

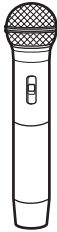

### Portable diversity tuner (URX-P1) (1)

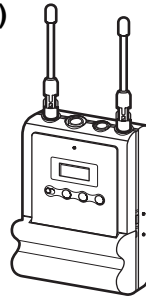

### Supplied accessories

- Microphone holder (1)

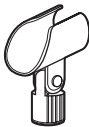

- Shoe mount adapter (1)

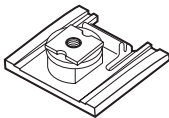

- Microphone stand adapter (1)



- Belt clip (1)

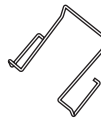

- XLR-BMP conversion cable (for use with the URX-P1 only) (1)

- Stereo mini plug-BMP conversion cable (for use with the URX-P1 only) (1)

- Operation manual (1)

# Configuration of the Packages

## UWP-S1

The UWP-S1 consists of a body-pack transmitter (UTX-B1) and a half-rack size diversity tuner (URX-R1). The UWP-S1 is suitable for constructing a wireless system for AV presentations.

### Body-pack transmitter (UTX-B1) (1)

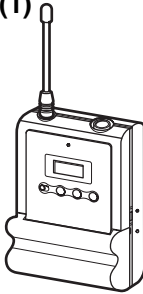

### Half-rack size diversity tuner (URX-R1) (1)

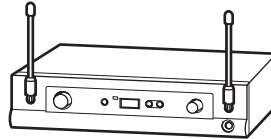

### Supplied accessories

- Unidirectional lavalier microphone (1)

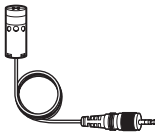

- Wind screen (1)



- Holder clip (1)



- AC adapter (1) (See page 47.)

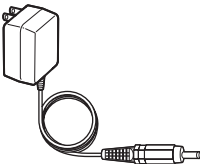

- Belt clip (1)

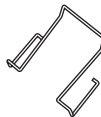

- Operation manual (1)

## UWP-S2

The UWP-S2 consists of a hand-held microphone (UTX-H1) and a half-rack size diversity tuner (URX-R1). The UWP-S2 is suitable for constructing a wireless system for AV presentations.

### Hand-held microphone (UTX-H1) (1)

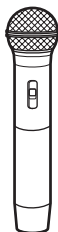

### Half-rack size diversity tuner (URX-R1) (1)

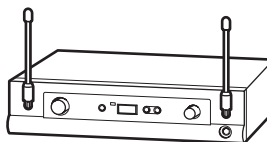

### Supplied accessories

- Microphone holder (1)

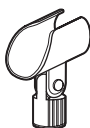

- AC adapter (1) (See page 47.)

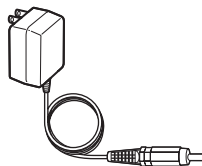

- Operation manual (1)

# Configuration of the Packages

## UWP-X1

The UWP-X1 consists of a body-pack transmitter (UTX-B1) and a diversity tuner module (URX-M1). By installing the tuner module into a tuner base unit or a powered mixer, the system construction to meet the desired purpose of use and required system scale becomes possible.

### Body-pack transmitter (UTX-B1) (1)

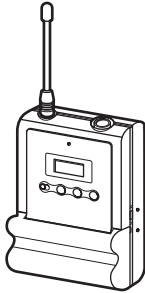

### Diversity tuner module (URX-M1) (1)

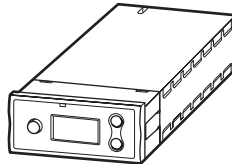

### Supplied accessories

- Unidirectional lavalier microphone (1)

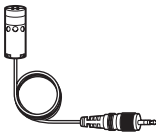

- Wind screen (1)



- Holder clip (1)



- Belt clip (1)

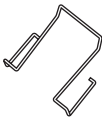

- Operation manual (1)



## UWP-X2

The UWP-X2 consists of a hand-held microphone (UTX-H1) and a diversity tuner module (URX-M1). By installing the tuner module into a tuner base unit or a powered mixer, the system construction to meet the desired purpose of use and required system scale becomes possible.

### Hand-held microphone (UTX-H1) (1)

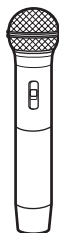

### Diversity tuner module (URX-M1) (1)

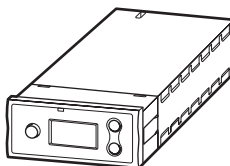

### Supplied accessories

- Microphone holder (1)



- Operation manual (1)

# Features

Each of the UWP-C1/C2/S1/S2/X1/X2 wireless microphone packages (referred to as the UWP series hereafter) combines a transmitter (body-pack transmitter (UTX-B1) or hand-held microphone (UTX-H1)) and a receiver (portable diversity tuner (URX-P1), half-rack size diversity tuner (URX-R1), or diversity tuner module (URX-M1)). The UWP series can be used with a compact camcorder for ENG (Electronic News Gathering) purposes, and with a powered mixer for AV presentations or as a PA (public address) system.

## Note

The UWP series is not compatible with conventional WRT series transmitters, WRR series tuners, or WRU series tuner units.

The features of each package are described below.

---

## UWP-C1

### Body-pack transmitter (UTX-B1)

This is a small and lightweight transmitter with a crystal-controlled PLL (phase lock loop) synthesized system and a BMP-type microphone input connector. The RF power output can be set at 10 mW or at 2 mW.

### Portable diversity tuner (URX-P1)

This tuner employs a space diversity system with little signal dropout and two angle-adjustable antennas. It comes with an adapter for mounting the tuner on the compact camcorder (DSR-PDX10/PDX10P/PD150/PD150P, etc.).

---

## UWP-C2

### Hand-held microphone (UTX-H1)

This microphone is equipped with a built-in antenna and a unidirectional dynamic microphone unit. The RF power output can be set at 10 mW or at 2 mW.

### Portable diversity tuner (URX-P1)

This tuner employs a space diversity system with little signal dropout and two angle-adjustable antennas. It comes with an adapter for mounting the tuner on the compact camcorder (DSR-PDX10/PDX10P/PD150/PD150P, etc.).

---

## UWP-S1

### Body-pack transmitter (UTX-B1)

This is a small and lightweight transmitter with a crystal-controlled PLL (phase lock loop) synthesized system and a BMP-type microphone input connector. The RF power output can be set at 10 mW or at 2 mW.

---

### **Half-rack size diversity tuner (URX-R1)**

This tuner employs a space diversity system with little signal dropout and two angle-adjustable antennas. It comes with two types of audio connectors (1/4-inch jack and XLR type) on the rear panel.

---

### **UWP-S2**

#### **Hand-held microphone (UTX-H1)**

This microphone is equipped with a built-in antenna and a unidirectional dynamic microphone unit. The RF power output can be set at 10 mW or at 2 mW.

### **Half-rack size diversity tuner (URX-R1)**

This tuner employs a space diversity system with little signal dropout and two angle-adjustable antennas. It comes with two types of audio connectors (1/4-inch jack and XLR type) on the rear panel.

---

### **UWP-X1**

#### **Body-pack transmitter (UTX-B1)**

This is a small and lightweight transmitter with a crystal-controlled PLL (phase lock loop) synthesized system and a BMP-type microphone input connector. The RF power output can be set at 10 mW or at 2 mW.

### **Diversity tuner module (URX-M1)**

This tuner module can be incorporated into the MB-806A Tuner Base Unit or SRP-X700P Powered Mixer.

---

### **UWP-X2**

#### **Hand-held microphone (UTX-H1)**

This microphone is equipped with a built-in antenna and a unidirectional dynamic microphone unit. The RF power output can be set at 10 mW or at 2 mW.

### **Diversity tuner module (URX-M1)**

This tuner module can be incorporated into the MB-806A Tuner Base Unit or SRP-X700P Powered Mixer.

# Precautions

- The UWP series product must be used within a temperature range of 0°C to 40°C (32°F to 104°F).
- Operating the UWP series product near electrical equipment (motors, transformers, or dimmers) may cause it to be affected by electromagnetic induction. Keep the UWP series product as far from such equipment as possible.
- The presence of the lighting equipment may produce electrical interference over the entire frequency range. Position the UWP series product so that interference is minimized.
- To avoid degradation of the signal-to-noise ratio, do not use the UWP series product in noisy places or in locations subject to vibration, such as the following:
  - near electrical equipment, such as motors, transformers or dimmers
  - near air conditioning equipment or places subject to direct air flow from an air conditioner
  - near public address loudspeakers
  - where adjacent equipment might knock against the tunerKeep the UWP series product as far from such equipment as possible or use buffering material.
- Clean the surface and the connectors of the UWP series product with a dry, soft cloth. Never use thinner, benzene, alcohol or any other chemicals, since these may mar the finish.

## **To prevent electromagnetic interference from portable communication devices**

The use of portable telephones and other communication devices near the UWP series product may result in malfunction and interference with audio signals. It is recommended that portable communication devices near the UWP series product be turned off.

# Parts Identification

## Body-pack transmitter (UTX-B1)

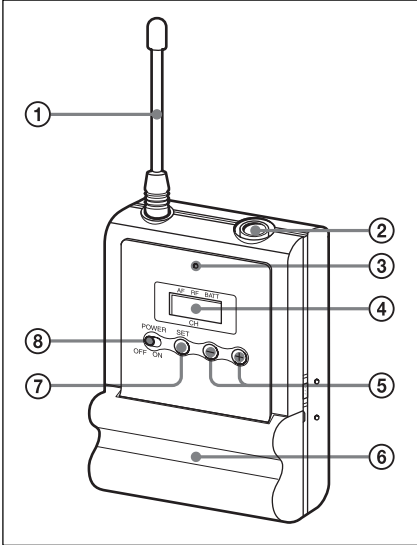

**1 Antenna**

**2 Audio input connector**  
Connect the supplied lavalier microphone here.

**3 Power indicator**  
Lights up red when the transmitter is tuned on.

**4 Display section**

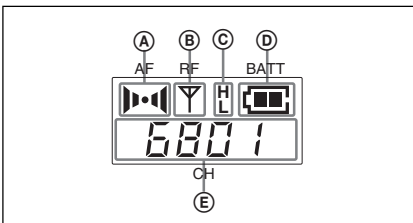

**A AF (audio frequency) indication**  
Appears whenever the input audio signal is stronger than the reference level.

**B RF (antenna output) indication**  
Appears during signal transmission from the antenna.

**C RF (antenna output) level indication**  
Shows the RF output level setting.  
*For details, see "Setting the RF output level" on page 32.*

**D BATT (battery) indication**  
Shows the battery condition.  
*For details, see "Power Supply" on page 20.*

**E CH (channel) indication**  
Shows the transmission channel. Each time you press the SET button in transmission mode, the channel indication changes as follows.  
*For details, see "Settings" on page 28.*

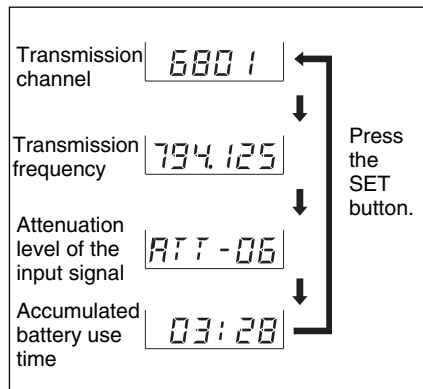

# Parts Identification

## 5 + (+ selection) / - (- selection/ reset) buttons

Press these buttons to set the transmission channel, frequency, or attenuation level of the input signal. The “-” button resets the accumulated battery use time to “00:00”.

## 6 Battery compartment

Accommodates two LR6 (size AA) alkaline batteries.

*For details on how to insert the batteries, see “Power Supply” on page 20.*

## 7 SET button

Press to change and enter display parameters.

*For details, see “Settings” on page 28.*

## 8 POWER switch

Turns the power of the transmitter ON or OFF.

## 1 Power indicator

Lights up red when the microphone is turned on.

## 2 POWER switch

Turns the power of the microphone ON or OFF.

## 3 Battery compartment

Accommodates two LR6 (size AA) alkaline batteries.

*For details on how to insert the batteries, see “Power Supply” on page 20.*

## 4 Display section

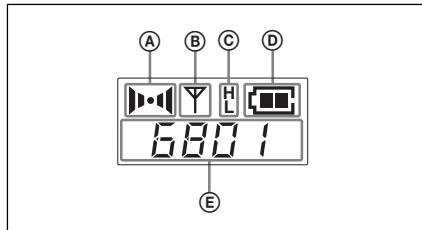

### A AF (audio frequency) indication

Appears whenever the input audio signal is stronger than the reference level.

### B RF (antenna output) indication

Appears during signal transmission from the antenna.

### C RF (antenna output) level indication

Shows the RF output level setting.

*For details, see “Setting the RF output level” on page 32.*

## Hand-held microphone (UTX-H1)

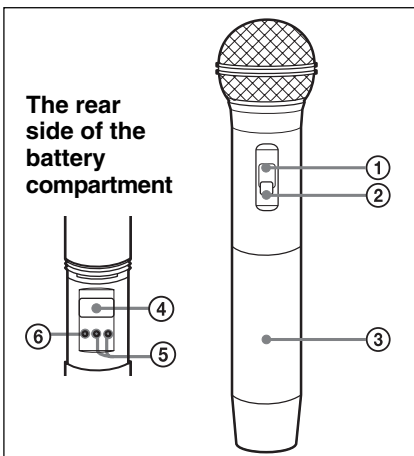

### ⓐ BATT (battery) indication

Shows the battery condition.

For details, see “Power Supply” on page 20.

### ⓔ CH (channel) indication

Shows the transmission channel. Each time you press the SET button, the channel indication changes as follows.

For details, see “Settings” on page 28.

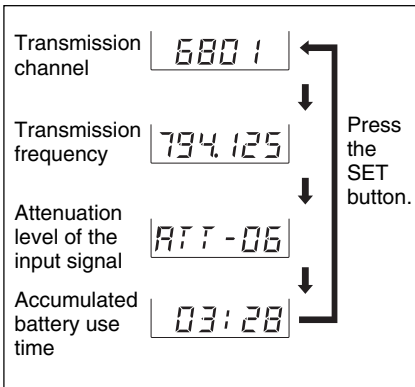

### ⓕ + (+ selection) / - (- selection/ reset) buttons

Press these buttons to set the transmission channel, frequency, or attenuation level of the input signal. The “-” button resets the accumulated battery use time to “00:00”.

### ⓖ SET button

Press to change display parameters. For details, see “Settings” on page 28.

## Portable diversity tuner (URX-P1)

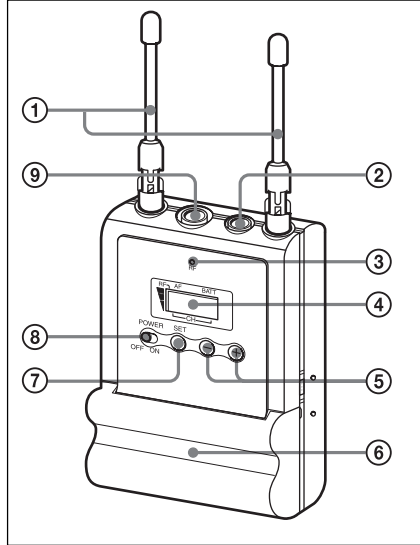

### ❶ Antennas a/b

The angle of the antennas can be adjusted manually.

### ❷ MONITOR connector (3.5-mm diameter stereo mini jack)

To monitor the tuner output, connect the headphones to this connector.

### ❸ RF (radio frequency) indicator

Indicates the strength of the RF input signal.

**On in green:** RF input is 15 dB $\mu$ \* or more.

**Off:** RF input is less than 15 dB $\mu$ \*.

\* 0 dB $\mu$  = 1  $\mu$ V<sub>EMF</sub>

# Parts Identification

## 4 Display section

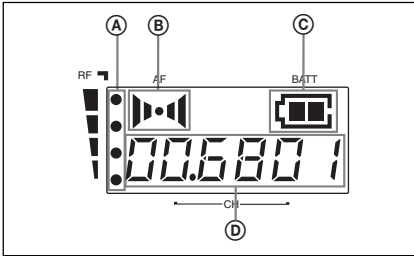

### A RF (radio frequency) indications

The number of dots indicates the RF input level.

### B AF (audio frequency) indication

Appears whenever the output audio signal is stronger than the reference level.

### C BATT (battery) indication

Shows the battery condition.

For details, see “Power Supply” on page 20.

### D GP (group)/CH (channel) indication

Shows the reception channel group and channel number. Each time you press the SET button, the channel indication changes as follows.

For details, see “Settings” on page 28.

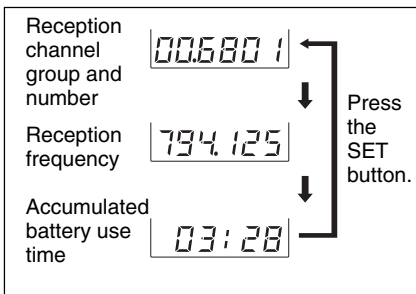

## 5 + (+ selection) / - (- selection/ reset) buttons

Press these buttons to set the reception channel and frequency. The “-” button resets the accumulated battery use time to “00:00”. These buttons can also be used to adjust the monitor level.

## 6 Battery compartment

Accommodates two LR6 (size AA) alkaline batteries.

For details on how to insert the batteries, see “Power Supply” on page 20.

## 7 SET button

Press to change display parameters. For details, see “Settings” on page 28.

## 8 POWER switch

Turns the power of the tuner ON or OFF.

## 9 OUTPUT (audio output) connector (3.5-mm diameter stereo mini jack)

Connect one end of the supplied XLR-BMP conversion cable or the stereo mini plug-BMP conversion cable here and the other end to the microphone input on a camcorder, mixer, or amplifier. If the microphone input connector on the device connected to the tuner is a stereo mini jack, connect the straight (BMP) plug (2-pole) to the tuner and the L-shaped (stereo mini) plug (3-pole) to the microphone input connector on the device.



## Half-rack size diversity tuner (URX-R1)

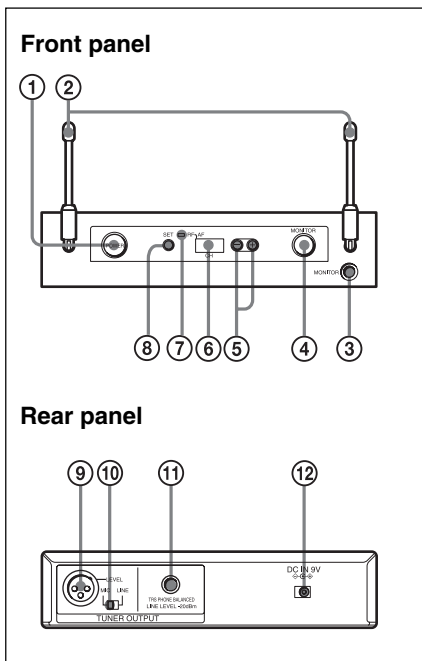

### ❶ POWER switch

Turns the power of the tuner ON or OFF.

### ❷ Antennas a/b

The angle of the antennas can be adjusted manually.

### ❸ MONITOR connector (phone jack)

To monitor the tuner output, connect the headphones to this connector and adjust the monitor level with the MONITOR control. Use either stereo or monaural headphones.

### ❹ MONITOR control

Turn to adjust the output monitoring level (through the headphones).

### ❺ + (+ selection) / - (- selection/ reset) buttons

Press these buttons to set the reception channel and frequency.

### ❻ Display section

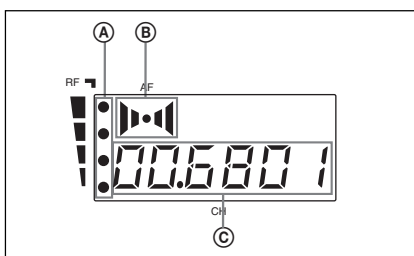

### Ⓐ RF (radio frequency) indications

The number of dots indicates the RF input level.

### Ⓑ AF (audio frequency) indication

Appears whenever the output audio signal is stronger than the reference level.

### Ⓒ GP (group)/CH (channel) indication

Shows the reception channel group and channel number. Each time you press the SET button, the channel indication changes as follows.

*For details, see "Settings" on page 28.*

# Parts Identification

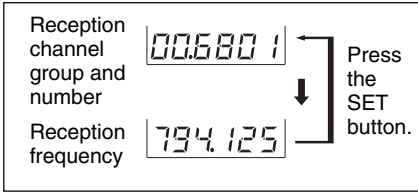

## 7 RF (radio frequency) indicator

Indicates the strength of the RF input signal.

**On in green:** RF input is 25 dB $\mu$ \* or more.

**Off:** RF input is less than 25 dB $\mu$ \*.

## 8 SET button

Press to change display parameters.  
*For details, see "Settings" on page 28.*

## 9 TUNER OUTPUT (audio output) connector (XLR type)

Connect to the audio input connector of a mixer or amplifier, etc.

## 10 LEVEL (audio output level) switch

Sets the output level of the TUNER OUTPUT connector (XLR type) to -28 dBm or -58 dBm.

Select the setting according to the input level of the equipment connected to the tuner.

## 11 TRS PHONE (tuner audio output) connector (1/4-inch jack)

Connect to the audio input connector of a mixer or amplifier, etc. The output level from this connector is -30 dBm.

## 12 DC IN 9V (DC power input) connector

Connect the supplied AC adapter here.

## Diversity tuner module (URX-M1)

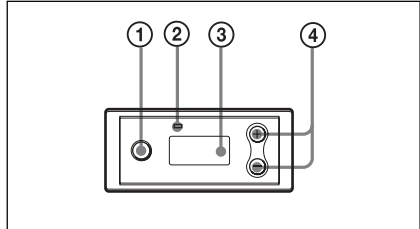

## 1 SET button

Press to change display parameters.  
*For details, see "Settings" on page 28.*

## 2 RF (radio frequency) indicator

Indicates the strength of the RF input signal.

**On in green:** RF input is 25 dB $\mu$ \* or more.

**Off:** RF input is less than 25 dB $\mu$ \*.

## 3 Display section

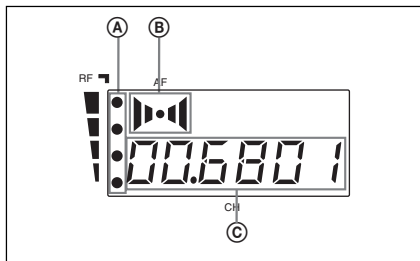

\* 0 dB $\mu$  = 1  $\mu$ V<sub>EMF</sub>

---

**Ⓐ RF (radio frequency) indications**

The number of dots indicates the RF input level.

**Ⓑ AF (audio frequency) indication**

Appears whenever the output audio signal is stronger than the reference level.

**Ⓒ GP (group)/CH (channel) indication**

Shows the reception channel group and channel number. Each time you press the SET button, the channel indication changes as follows.

*For details, see “Settings” on page 28.*

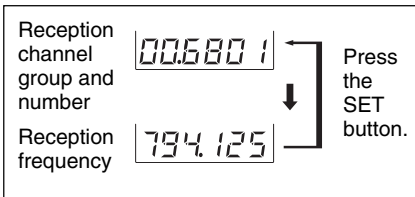

**④ + (+ selection) / - (- selection/ reset) buttons**

Press these buttons to set the reception channel and frequency.

# Power Supply

This section explains the power supply for each component.

- **Half-rack size diversity tuner (URX-R1)**

Connect the supplied AC adapter to the DC IN 9V connector on the rear panel, and then connect the AC adapter to a wall outlet.

- **Diversity tuner module (URX-M1)**

When incorporated into another component (e.g., MB-806A, SRP-X700P, etc.), the tuner module draws its power from that component.

*For details on the power supply to the diversity tuner module, refer to the operating instructions of the component in which the diversity tuner module is installed.*

- **Body-pack transmitter (UTX-B1), hand-held microphone (UTX-H1), and portable diversity tuner (URX-P1)**

These components can be powered by two LR6 (size AA) alkaline batteries for about six hours of continuous operation (at 25 °C (77°F)). Details on inserting the batteries and the battery condition indication are given below:

## Inserting the batteries

### Body-pack transmitter (UTX-B1)/portable diversity tuner (URX-P1)

The procedure below uses the body-pack transmitter (UTX-B1) in the illustrations. Batteries are, however, inserted in the portable diversity tuner (URX-P1) in the same manner.

- 1 Slide the latches on both sides of the transmitter/tuner at the same time and open the battery compartment.

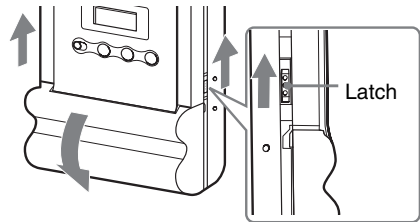

- 2 Align two new LR6 (size AA) alkaline batteries with the polarity markings and insert them into the battery compartment, and then close the cover.

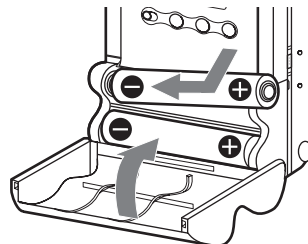

## Hand-held microphone (UTX-H1)

- 1 Turn the grip in the direction of the arrow to open the battery compartment.

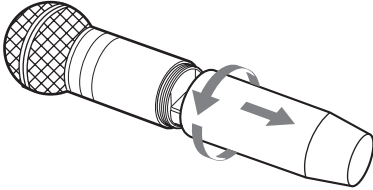

- 2 Align two new LR6 (size AA) alkaline batteries with the polarity markings and insert them into the battery compartment.

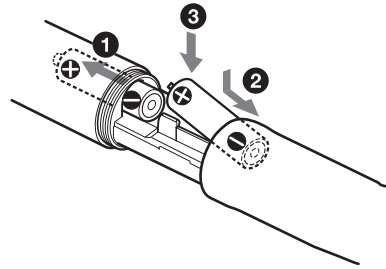

- 3 Turn the grip in the direction opposite to the arrow in step 1 to close the battery compartment.





### Note

If you open the battery compartment during signal transmission, the noise may occur. Be sure to turn the microphone off before opening the battery compartment.

## Battery indication

When you turn the power on, the battery condition is shown by the BATT indication in the display section.

When the indication in column 4 starts to flash, replace the batteries with new ones. Be sure to check the expiration date printed on the new batteries before using them.

	1	2	3	4
<b>BATT indication</b>	Lights 	Lights 	Lights 	Flashes 
<b>Battery status</b>	Good	Less than 50% charged	Less than 20% charged	Almost drained

**Note**

The indicated battery condition may not be correct if the batteries were not new when installed. If you plan to use the component for a long period, it is recommended that you replace the batteries with brand new ones.

---

## Notes on batteries

Batteries may leak or explode if mistreated. Be sure to follow these instructions.

- Be sure to install the batteries with the correct polarity.
- Always replace the two batteries together.
- Do not use different types of batteries or old and new one together.
- The batteries are not rechargeable.
- When not using the component for a long period of time, remove the batteries to avoid leakage. If the batteries do leak, clean all leakage from the battery compartment and the component. Leakage left in the compartment and the component may cause poor battery contact. If there seems to be poor battery contact, consult your Sony dealer.

# Attachment and Installation Procedures

This section describes the procedures for attaching the supplied accessories to components and the installation of the diversity tuner module (URX-M1) into the MB-806A Tuner Base Unit or SRP-X700P Powered Mixer.

## Attaching the supplied accessories to the body-pack transmitter (UTX-B1)

### Attaching the microphone

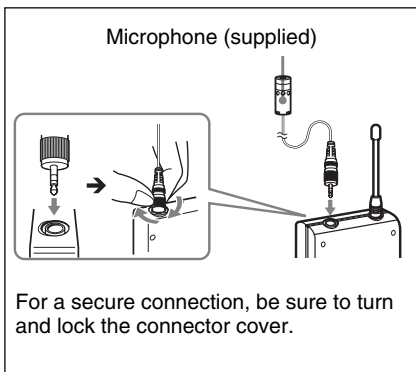

### Attaching the holder clip to the microphone

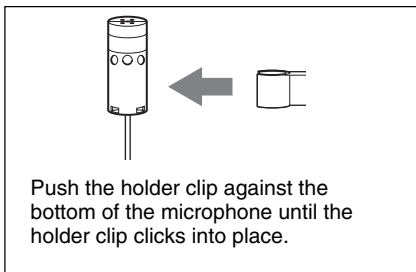

### Attaching the wind screen to the microphone

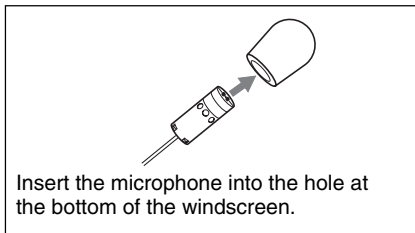

### Attaching the belt clip

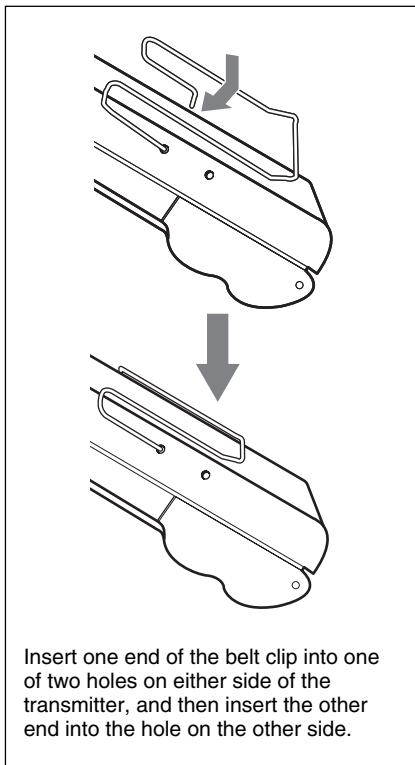

# Attachment and Installation Procedures

## Removing the belt clip

Insert a pointed object such as a ballpoint pen between the belt clip and the transmitter to make some space between them, and then remove the end of the belt clip from the hole on the side of the transmitter.

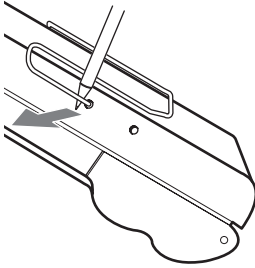

## Attaching the supplied accessory to the hand-held microphone (UTX-H1)

## Attaching the microphone holder

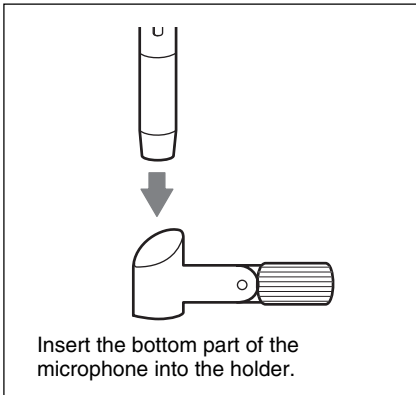

## Attaching the supplied accessories to the portable diversity tuner (URX-P1)

## Connecting the supplied conversion cable to the OUTPUT connector

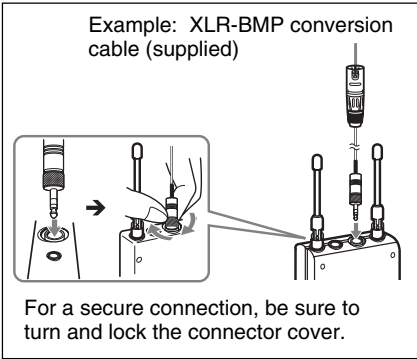

### Note

The supplied conversion cables are for use with the URX-P1 only. Attaching the cable to the audio input connector of the UTX-B1 may cause damage to the transmitter or the device connected to the transmitter.

## Attaching the belt clip

See “Attaching the belt clip” on page 23.



## Attaching the shoe mount adapter

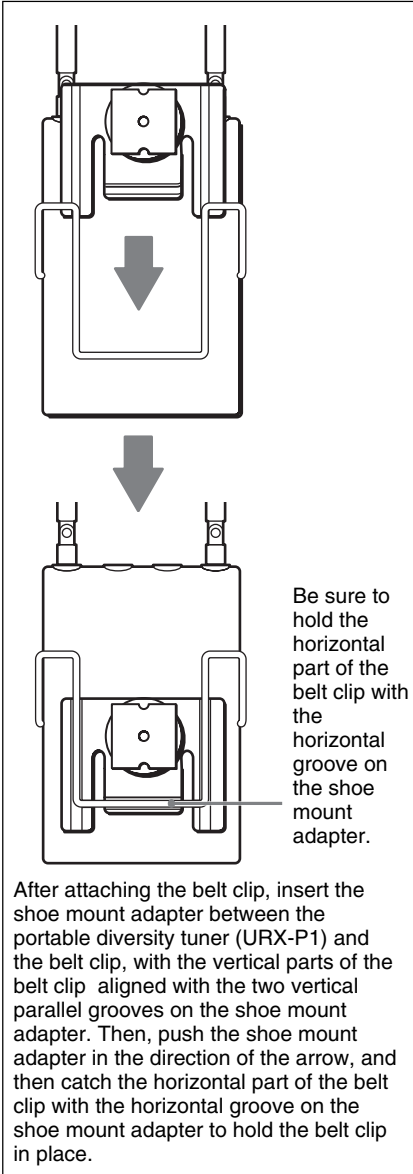

## Attaching the microphone stand adapter

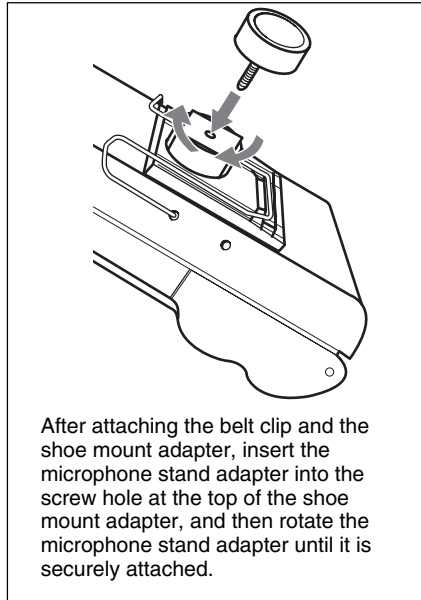

## Installing the diversity tuner module (URX-M1)

### Notes

- Before installing the diversity tuner module (URX-M1), make sure the unit into which the diversity tuner module (URX-M1) will be installed is turned off. Do not install or uninstall the diversity tuner module (URX-M1) while the unit is turned on, as this may damage the connector or cause noise.

# Attachment and Installation Procedures

- The buttons and display on the front panel of the diversity tuner module (URX-M1) may be damaged if they are gripped too strongly. Always hold the diversity tuner module by the side.
- Do not put your fingers on the connectors on the rear panel of the diversity tuner module (URX-M1) or into the slot on the unit into which the diversity tuner module (URX-M1) will be installed.
- Keep the diversity tuner module (URX-M1) away from static electricity.

## Installing a diversity tuner module (URX-M1) into an MB-806A Tuner Base Unit

The MB-806A Tuner Base Unit can accommodate up to 6 diversity tuner modules (URX-M1).

- 1** Holding both sides of the diversity tuner module (URX-M1), insert it into the slot.

Push it in until you hear a click.

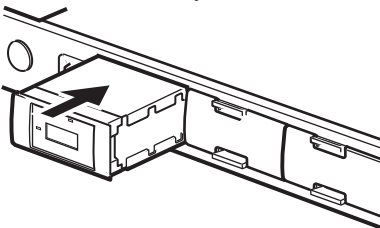

- 2** To install two or more diversity tuner modules (URX-M1), detach the necessary number of blank panels by pressing the top and bottom tabs on each panel towards each other and pulling the panel out. Then do step 1 for each module.

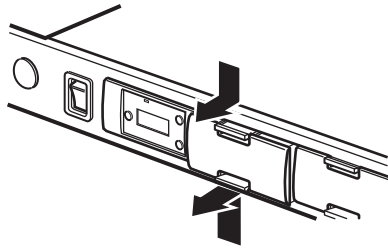

## Removing a diversity tuner module (URX-M1)

On the bottom panel of the MB-806A, locate the lever corresponding to the slot of the diversity tuner module (URX-M1) to be removed and pull the lever forward. The diversity tuner module (URX-M1) is ejected from the slot.

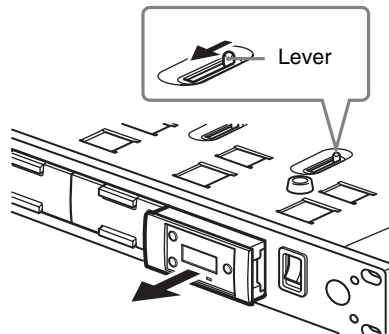

## Installing a diversity tuner module (URX-M1) into an SRP-X700P Powered Mixer

The SRP-X700P Powered Mixer can accommodate up to 2 diversity tuner modules (URX-M1).

- 1 Remove the tuner slot cover from the SRP-X700P and inspect the top and bottom sides of the diversity tuner module. Then, holding the tuner module on both sides, insert it into the slot.

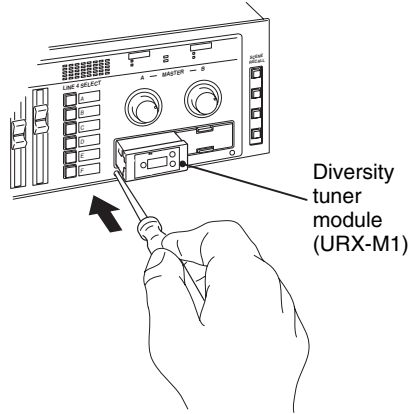
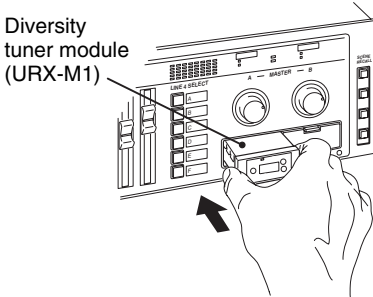

## Removing the diversity tuner module (URX-M1)

Insert a screwdriver with a shaft diameter of between 2 to 4 mm and a shaft length of 30 mm or longer into the hole under the lower part of the tuner slot and remove the tuner module.

# Settings

## Setting the transmission channel

**The procedure below is the same for all UWP series transmitters (UTX-B1/H1).**

See “Wireless microphone system frequency list” on page 45 for details on the selectable channel groups and channels.

- 1** Turn on the transmitter while pressing down the SET button.

Keep pressing the SET button until the display section parameters that were displayed when the unit was last turned off start to flash.

- 2** Press the SET button repeatedly until the channel number (or frequency) indication appears.

- 3** Press the + or – button to select the channel number (or frequency).

Pressing the + button cycles the indication in the order shown in the tables in “Wireless microphone system frequency list” on page 45.

Pressing the – button cycles the indications in the opposite direction.

Hold down the + or – button to change the channel number (or frequency) faster.

- 4** When the desired channel number (or frequency) appears, set the POWER switch to OFF to complete the setting, or press the SET button to set other items.

The results are stored in memory. The stored channel number (or frequency) will appear in the display section the next time you turn on the transmitter by setting the POWER switch to ON.

### Notes

- When you are setting the transmission channel, the transmitter cannot be used to transmit signals.
- Do not remove the batteries while setting the transmission channel. If they are inadvertently removed, re-insert them immediately and redo the procedure “Setting the transmission channel” from step 1.
- Make sure that the selected channel is the same on the transmitter and tuner being used in the same system.
- If you turn off the transmitter and then immediately turn it on right after setting the transmission channel, the unit may not operate normally. Wait a few seconds before turning it on again.

## Setting the reception channel

The procedure below is the same for all UWP series tuners (URX-P1/R1/M1).

See “Wireless microphone system frequency list” on page 45 for details on the selectable channel groups and channels.

- 1 Press down the SET button for more than one second.

Keep pressing the SET button until the display section parameters start to flash.

- 2 Press the SET button repeatedly until the channel group and the channel number indications appear.

The channel group indication starts to flash.



- 3 Press the + or – button to select the channel group.

Pressing the + button cycles the indication in the order shown in the tables in “Wireless microphone system frequency list” on page 45. Pressing the – button cycles the indications in the opposite direction.

Hold down the + or – button to change the channel group faster.

- 4 When the desired channel group number appears, press the SET button.

The selected group is entered. The right four digits start to flash to allow the selection of the channel number.



- 5 Press the + or – button to select the channel number.

The channel indication changes in the order shown in the tables in “Wireless microphone system frequency list” on page 45.

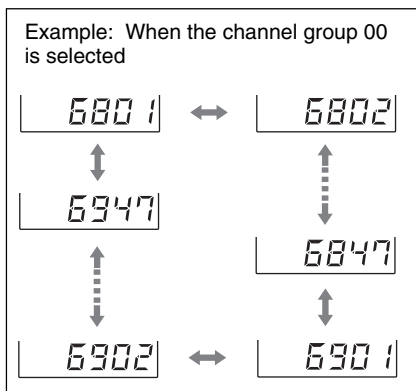

- 6 When the desired channel number appears, leave the tuner for about 10 seconds until the selected channel number stops flashing and the selection is stored in memory.

# Settings

## To select the channel by frequency indication

- 1 Press the SET button for more than one second.

Keep pressing the SET button until the display section parameters start to flash.

- 2 Press the SET button repeatedly until the frequency indication appears and starts flashing.



- 3 Press the + or – button to select the frequency.
- 4 When the desired frequency appears, leave the tuner for about 10 seconds until the selected channel frequency stops flashing and the selection is stored in memory.

### Notes

- When you are setting the reception channel, the tuner can be used to receive signals.
- Do not remove the batteries while setting the reception channel. If they are inadvertently removed, re-insert them immediately and redo the procedure “Setting the reception channel” from step 1.
- Make sure that the selected channel is the same on the transmitter and tuner being used in the same system.

- If you turn off the tuner and then immediately turn it on right after setting the reception channel, the unit may not operate normally. Wait a few seconds before turning it on again.

## Detecting and selecting the available channels automatically (diversity tuner module (URX-M1) only)

When multiple diversity tuner modules (URX-M1) are installed into the MB-806 to perform simultaneous multiple-channel operation, select the channel group on the tuner module installed into the slot **1** of the MB-806, then all the tuner modules installed into the MB-806 can be set to different channels within the selected channel group.

- 1 Turn off all the microphones and transmitters.
- 2 Select the channel group on the tuner module installed into the slot **1** of the MB-806.
- 3 After confirming that the channel group indication has stopped flashing (about 10 seconds after you have selected the channel group), keep pressing the + button on the tuner module installed into the slot **1** of the MB-806.

All the tuner modules installed into the MB-806 are set to the available channels within the selected channel group. After the automatic detection and selection of available channels finish, you can change the group and channel on each tuner module manually.

#### Notes

- Do the automatic detection and selection of available channels with the channel group other than channel group 00.
- When there are unavailable channels due to extraneous radio wave and the channel could not be selected on some tuner modules, “NO CH” appears on the display of those tuner modules. If this happens, select the channel group with no interference from extraneous radio wave, and repeat the procedure above.

### Setting the attenuation level of the audio input

**The procedure below is the same for all UWP series transmitters (UTX-B1/H1).**

The attenuation level can be set during signal transmission.

#### 1 Do the following while there is no signal transmission.

Turn on the transmitter while pressing down the SET button, and press the SET button repeatedly until the attenuation level indication appears in the display section.



#### Do the following while there is signal transmission.

Press the SET button repeatedly until the attenuation level indication appears in the display section.

#### 2 Press the + or – button to select the attenuation level.

The selectable range is from 0 dB to 21 dB in steps of 3 dB (the factory setting is 0 dB).

#### 3 Do the following while there is no signal transmission.

Set the POWER switch to OFF to complete the setting, or press the SET button to set other items.

The results are stored in memory. The change becomes effective the next time you turn on the transmitter by setting the POWER switch to ON.

## Resetting the accumulated battery use time indication

The procedure below is the same for all UWP series transmitters (UTX-B1/H1) and the portable diversity tuner (URX-P1).

The accumulated battery use time is the total time (in hours and minutes) that the batteries have been used. It is recorded whenever the transmitter/microphone/tuner is on. Reset the indication to “00:00” whenever you replace the batteries.

### 1-a For transmitters (UTX-B1/H1)

Turn on the unit while pressing down the SET button.

### 1-b For the portable diversity tuner (URX-P1)

Press down the SET button for more than one second.

Keep pressing the SET button until the display section parameters start to flash.

- 2 Press the SET button repeatedly until the accumulated time indication appears in the display section.

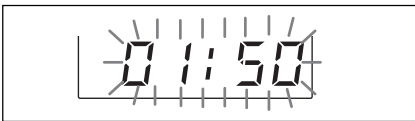

- 3 Press the – button.

The time indication resets to “00:00.”

While “00:00” is still displayed, you can return to previous value by pressing the + button.

### 4-a For transmitters (UTX-B1/H1)

Set the POWER switch to OFF to complete the setting, or press the SET button to set other items.

The results are stored in memory. The change becomes effective the next time you turn on the unit by setting the POWER switch to ON.

### 4-b For the portable diversity tuner (URX-P1)

Leave the tuner for about 10 seconds until the time indication stops flashing and the setting is stored in memory.

## Setting the RF output level

The procedure below is the same for all UWP series transmitters (UTX-B1/H1).

You can select an RF output level of H (10 mW) or L (2 mW) in setting mode. Set the RF output level to L (2 mW) for simultaneous operation of multiple channels, and set it to H (10 mW) for long-distance operation.

- 1 Turn on the transmitter while pressing down the SET button.



- 2 Press the SET button repeatedly until the RF output level indication appears in the display section.



- 3 Press the + button to select H (10 mW), or press the – button to select L (2 mW).
- 4 Set the POWER switch to OFF to complete the setting, or press the SET button to set other items.

The results are stored in memory. The change becomes effective the next time you turn on the transmitter by setting the POWER switch to ON.

### Setting the monitor level (portable diversity tuner (URX-P1) only)

You can set the monitor level for monitoring the tuner output within the range of 01 to 24.

- 1 While the parameters on the display section are not flashing, press the + or – button once.

The monitor level indication appears in the display section.



- 2 Press the + button to increase the monitor level, or press the – button to decrease the level.

When you leave the tuner for about two seconds or more, current monitor level setting is stored in memory and the normal display resumes. Note that monitor level setting is effective after you turn off the tuner, then turn it on again.

**The procedure below is the same for all UWP series components (UTX-B1/H1 and URX-P1/R1/M1).**

- 1** Make all necessary connections on the tuner.

*For examples of UWP series component connections, see “System Configurations” on page 35.*

- 2** Set the transmission channel on the transmitter, and then turn off the unit.

*For details on setting the transmission channel, see “Setting the transmission channel” on page 28.*

- 3** Turn on the tuner.

The parameters that were in the display section when the tuner was last turned off appear again.

#### **Note**

Before turning on the tuner, turn down the volume of the equipment connected to the tuner. Otherwise, noise will be produced when the tuner is turned on.

- 4** Set the reception channel on the tuner.

*For details on setting the reception channel, see “Setting the reception channel” on page 29.*

- 5** Turn on the transmitter.

---

## **If noise is heard**

Depending on the environment where the UWP series components are installed, external noise or radio waves may disrupt transmission on certain channels.

When selecting a channel under these circumstances, turn off the transmitter. Then, on the tuner, select a channel for which the RF indications do not appear in the display section or for which the RF indicator does not light up (i.e., a channel free from noise or radio wave interference). Set the same channel on the transmitter.

#### **Note**

To prevent interference or noise, please take the following precautions.

- Do not use two or more transmitters with the same wireless channels.
- When operating two or more UWP series simultaneously, set each series to a different channel within the same channel group.
- Keep the reception antenna and the transmitter separated more than 3 meters (9 feet 11 inches).
- When operating two or more UWP series simultaneously with the same channel group, make sure that they are at least 100 meters (330 feet) apart, but within clear sight of each other. (The actual distance may differ depending on the circumstances.)

# System Configurations

The UWP series is used in the following configuration examples.

## Sample configurations for ENG (Electronic News Gathering) or EFP (Electronic Field Production) with a digital camcorder

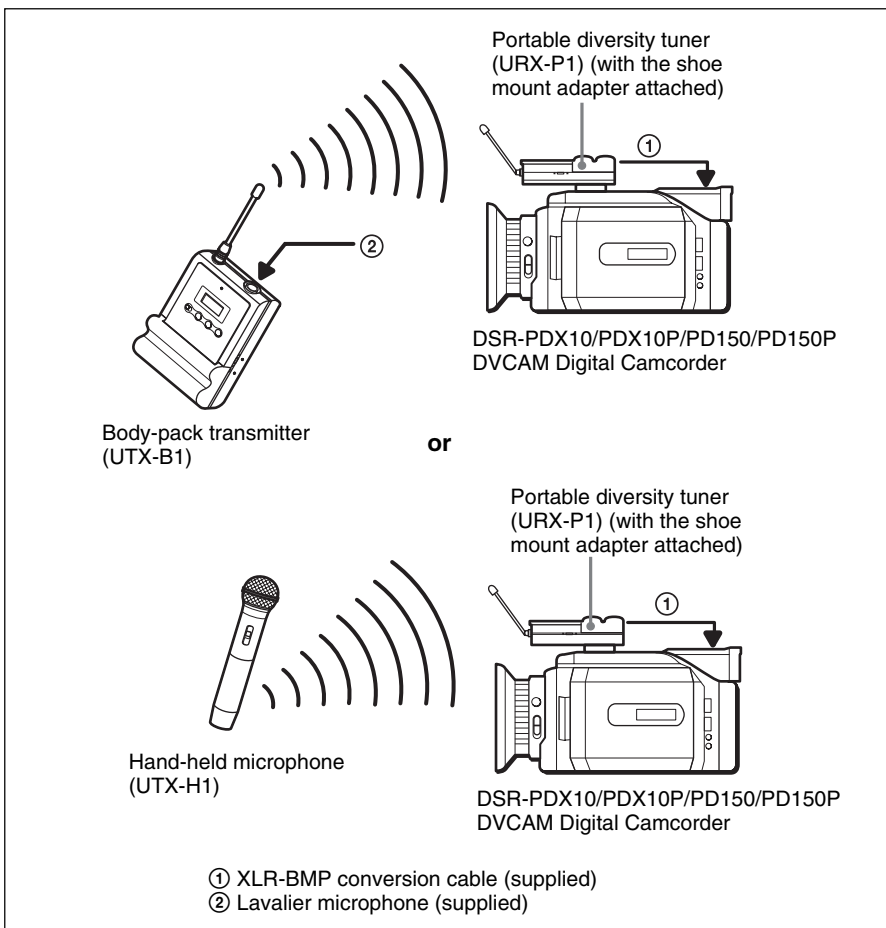

# System Configurations

## Sample configurations for AV presentations

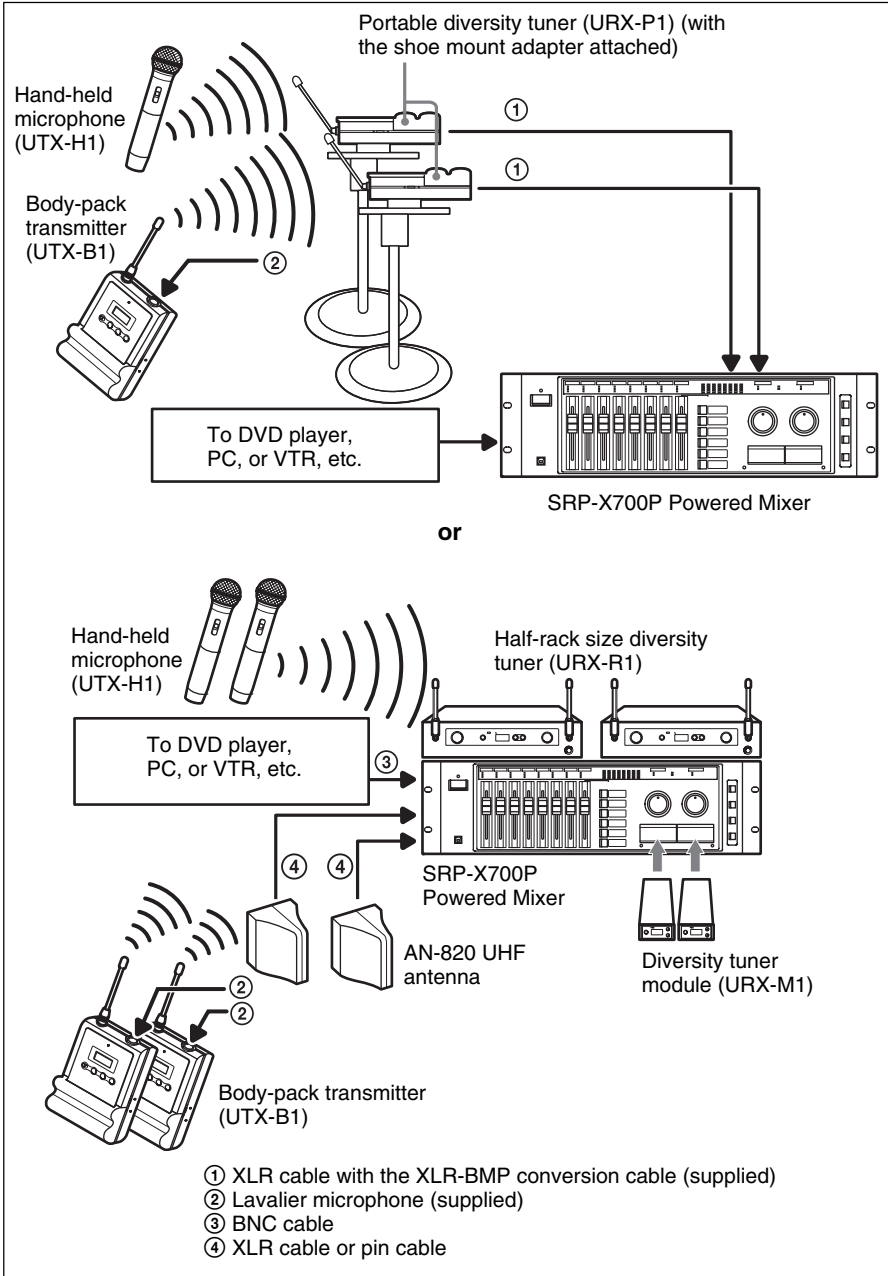

## Sample configuration of a PA system

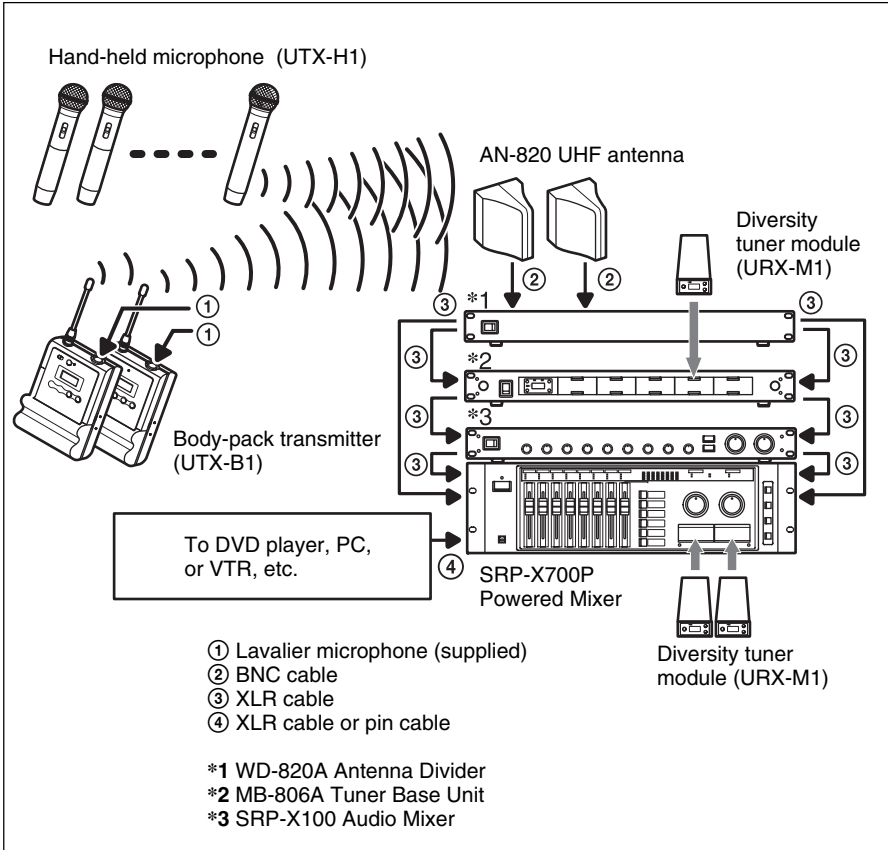

# Error Messages

When a problem occurs, one of the following error messages may appear on the display.

<b>Messages</b>	<b>Meanings</b>	<b>Remedy</b>
Err 01	An error has occurred in the backup memory data.	Contact your Sony dealer.
Err 02	The PLL synthesized circuit is abnormal.	Restart the unit. If the message appears again, contact your Sony dealer.
Err 03*	The battery voltage exceeds the allowable limit.	Use the specified batteries.

\* Body-pack transmitter (UTX-B1)/hand-held microphone (UTX-H1)/portable diversity tuner (URX-P1) only.

# Troubleshooting

If you have any problem using the UWP system, use the following checklist. Should any problem persist, consult your Sony dealer.

Symptom	Meanings/Remedy
The unit does not turn on*.	The polarity orientation of the batteries in the battery compartment is incorrect. ➔ Insert the batteries with the correct polarity orientation.
	The batteries are exhausted. ➔ Replace the batteries with new ones.
	The battery terminals in the transmitter are dirty. ➔ Clean the + and – terminals with a cotton swab.
The batteries become drained quickly*.	The batteries are exhausted. ➔ Replace the batteries with new ones.
	Manganese batteries are being used. ➔ Use alkaline batteries. The battery life of a manganese battery is less than half that of an alkaline battery.
	The UWP series is being used under cold conditions. ➔ The batteries drain quickly under cold conditions.
The channel cannot be changed.	An attempt was made to change the channel by pressing the SET button only. ➔ Restart the unit while holding down the SET button. Then change the channel with the + and – buttons.
There is no sound.	The channel setting on the transmitter is different from that on the tuner. ➔ Use the same channel setting on both the transmitter and tuner.
	The RF indications (RF indicator) on the tuner do not appear at all (or does not turn on). ➔ Confirm that the transmitter is turned on.
The sound is weak.	The attenuation level on the transmitter is too high. ➔ The output level of the transmitter is low. Press the + button on the transmitter in attenuation level setting mode to decrease the attenuation level.
	The volume on the amplifier or mixer is low. ➔ Adjust the volume.

\* Body-pack transmitter (UTX-B1)/hand-held microphone (UTX-H1)/portable diversity tuner (URX-P1) only.

# Troubleshooting

Symptom	Meanings/Remedy
There is distortion in the sound.	The attenuation level of the transmitter is too low. ➔ The input level of the tuner is extremely high. Press the – button on the transmitter in attenuation level setting mode to raise the attenuation level.
	The transmitter and the tuner are set to different channels. ➔ Set the transmitter to the same channel.
There is sound interruption or noise.	The RF indications on the tuner appear (the RF indicator lights up) even when the transmitter is off. ➔ Jamming radio waves are being received. Determine which channels are usable (i.e., channels for which the RF indications on the tuner do not appear (or for which the RF indicator on the tuner does not light up) and set the tuner and transmitter to the same usable channel. When two or more transmitters are used simultaneously, use another channel group that is unaffected by jamming radio waves.
	The transmitter and the tuner are set to different channels. ➔ Set the transmitter to the same channel.
	Two or more transmitters are set to the same channel. ➔ Set each transmitter to a different channel.
	The transmitters are not set to the channels within the same channel group. ➔ The channel plan which the UWP series components use is set so that no signal interference occurs when 2 or more transmitters are used simultaneously. Set each transmitter to a different channel within the same channel group.



# Specifications

## Transmitters (UTX-B1/H1)

### Items common to all transmitters

Oscillator type	Crystal-controlled PLL synthesizer
Carrier frequencies	794 to 806 MHz
Operating frequency band	12 MHz
RF output level	10 mW/2 mW selectable
Pre-emphasis	50 $\mu$ s
Reference deviation	$\pm 5$ kHz
Frequency characteristics	50 Hz to 18 kHz
Distortion	1.0% or less
Signal-to-noise ratio	60 dB or more
Tone signal	32 kHz
Attenuation	0 to 21 dB, in 3-dB steps
Display	Channel, frequency, audio level, RF level, accumulated battery use time
Indicator	Power on
Power requirements	3.0 V DC (two LR6/AA-size alkaline batteries)
Battery life	Approx. 6 hours

## Body-pack transmitter (UTX-B1)

Antenna	$1/4\lambda$ (wave length) wire
Audio input connector	3.5-mm dia. mini jack
Audio input level	-60 dBV to -39 dBV

### Dimensions

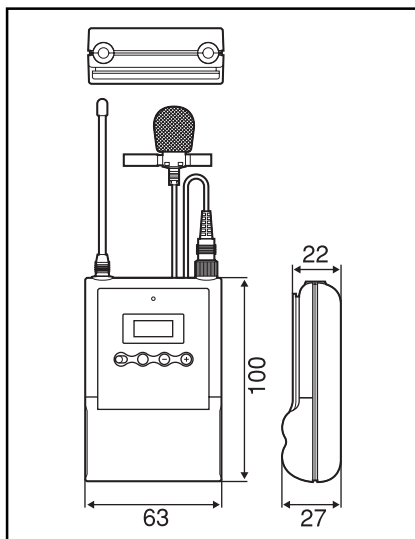

63 × 100 × 27 mm (2 1/2 × 4 × 1 1/8 inches) (w/h/d) (excluding the antennas)

Mass	Approx. 140 g (5 oz) including batteries
------	--

# Specifications

## Hand-held microphone (UTX-H1)

- Microphone unit  
Dynamic
- Directivity  
Unidirectional
- Antenna  $1/4\lambda$  (wave length) wire  
(internal)
- Dimensions

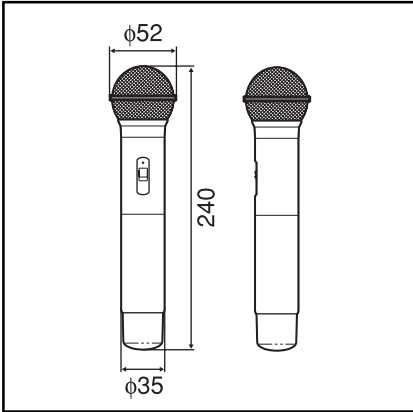

$\phi 52 \times 240$  mm ( $2 \frac{1}{8} \times 9 \frac{1}{2}$  inches) (dia/length)

- Mass  
Approx. 300 g (11 oz)  
including batteries

## Tuners (URX-P1/R1/M1)

### Items common to all tuners

- Type of reception  
Space diversity
- Oscillator type  
Crystal-controlled PLL  
synthesizer
- Reception frequencies  
794 to 806 MHz
- Operating frequency band  
12 MHz
- Signal-to-noise ratio  
60 dB or more
- De-emphasis  
50  $\mu$ s
- Reference deviation  
 $\pm 5$  kHz
- Frequency characteristics  
50 Hz to 18 kHz
- Distortion  
1.0% or less at 1 kHz  
modulation
- Tone signal  
32 kHz
- Indicator  
RF input level

### Portable diversity tuner (URX-P1)

- Antenna  $1/4\lambda$  (wave length) wire  
(adjustable angle)
- Squelch level  
15 dB $\mu$
- Audio output level  
-58 dBm
- Audio output connector  
3.5 mm dia. mini jack
- Headphones output level  
5 mW (16 $\Omega$ )

Display Channel, frequency, audio level, RF level, accumulated battery use time, monitor level

Power requirements  
3.0 V DC (two LR6/AA-size alkaline batteries)

Battery life  
Approx. 6 hours

Dimensions

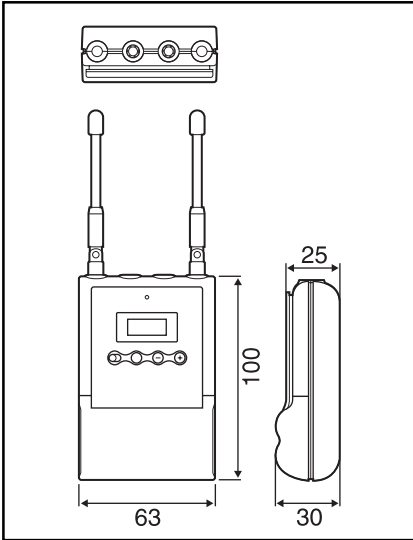

$63 \times 100 \times 30$  mm ( $2 \frac{1}{2} \times 4 \times 1 \frac{3}{16}$  inches) (w/h/d) (excluding the antennas)

Mass  
Approx. 180 g (6 oz) including batteries

## Half-rack size diversity tuner (URX-R1)

Antenna  $\frac{1}{4}\lambda$  (wave length) wire (adjustable angle)

Squelch level  
25 dB $\mu$

Balanced audio output level  
-28 dBm (LINE level)/-58 dBm (MIC level) selectable

Unbalanced audio output level  
-30 dBm

Audio output connectors  
XLR-3-32 type, balanced  
1/4-inch jack, unbalanced (LINE level only)

Headphones output level  
5 mW (16 $\Omega$ )

Display Channel, frequency  
Power requirements  
9.0 V DC

Dimensions

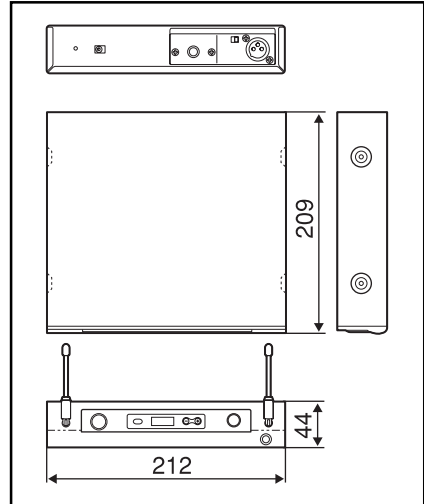

$212 \times 44 \times 209$  mm ( $8 \frac{3}{8} \times 1 \frac{3}{4} \times 8 \frac{1}{4}$  inches) (w/h/d) (excluding the antennas)

# Specifications

---

Mass      Approx. 1.3 kg (2 lb 14 oz)

## Diversity tuner module (URX-M1)

Squelch level

25 dB $\mu$

Display    Channel, frequency

Dimensions

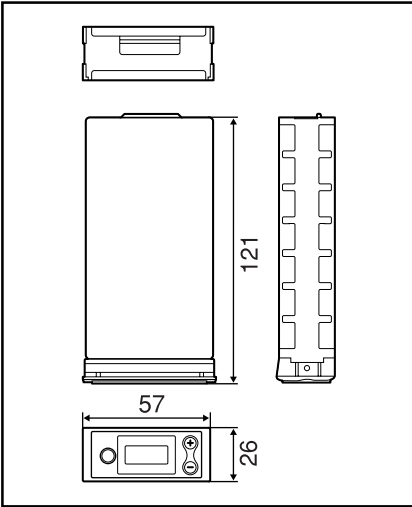

$57 \times 26 \times 121$  mm ( $2 \frac{1}{4} \times 1 \frac{1}{16} \times 4 \frac{7}{8}$  inches) (w/h/d)

Mass      Approx. 150 g (5 oz)

Design and specifications are subject to change without notice.

# Appendix

## Wireless microphone system frequency list

The following tables show the channels and frequencies selectable on your wireless microphone, transmitter and tuner.

The group 00 permits the unit to operate on any of 47 carrier frequencies in 125 kHz steps of TV channels 68 and 69.

For the setting procedures of the transmitting channels/frequencies on your unit, refer to the Instruction Manual of your unit. Be sure to save this list together with the Instruction Manual of your unit.

### Guidance on the use of a multi-channel system

When building up a multi-channel system, Sony recommends that one of the groups listed under “Groups for the tuner” is selected to avoid mutual interference from other Sony wireless microphones/transmitters.

### Group for transmitter and tuner

#### Group 00

##### TV-68

CH	MHz	CH	MHz
68-01	794.125	68-25	797.125
68-02	794.250	68-26	797.250
68-03	794.375	68-27	797.375
68-04	794.500	68-28	797.500
68-05	794.625	68-29	797.625
68-06	794.750	<b>68-30</b>	<b>797.750</b>
68-07	794.875	68-31	797.875
68-08	795.000	68-32	798.000
68-09	795.125	68-33	798.125
<b>68-10</b>	<b>795.250</b>	68-34	798.250
68-11	795.375	68-35	798.375
68-12	795.500	68-36	798.500
68-13	795.625	68-37	798.625
68-14	795.750	68-38	798.750
68-15	795.875	68-39	798.875
68-16	796.000	<b>68-40</b>	<b>799.000</b>
68-17	796.125	68-41	799.125
68-18	796.250	68-42	799.250
68-19	796.375	68-43	799.375
<b>68-20</b>	<b>796.500</b>	68-44	799.500
68-21	796.625	68-45	799.625
68-22	796.750	68-46	799.750
68-23	796.875	68-47	799.875
68-24	797.000		

##### TV-69

CH	MHz	CH	MHz
69-01	800.125	69-25	803.125
69-02	800.250	69-26	803.250
69-03	800.375	69-27	803.375
69-04	800.500	69-28	803.500
69-05	800.625	69-29	803.625
69-06	800.750	<b>69-30</b>	<b>803.750</b>
69-07	800.875	69-31	803.875
69-08	801.000	69-32	804.000
69-09	801.125	69-33	804.125
<b>69-10</b>	<b>801.250</b>	69-34	804.250
69-11	801.375	69-35	804.375
69-12	801.500	69-36	804.500
69-13	801.625	69-37	804.625
69-14	801.750	69-38	804.750
69-15	801.875	69-39	804.875
69-16	802.000	<b>69-40</b>	<b>805.000</b>
69-17	802.125	69-41	805.125
69-18	802.250	69-42	805.250
69-19	802.375	69-43	805.375
<b>69-20</b>	<b>802.500</b>	69-44	805.500
69-21	802.625	69-45	805.625
69-22	802.750	69-46	805.750
69-23	802.875	69-47	805.875
69-24	803.000		

# Appendix

## Groups for tuner

### Group 11

Grouping 11 channels.

CH	MHz
68-05	794.625
68-14	795.750
68-25	797.125
68-41	799.125
68-47	799.875
69-12	801.500
69-16	802.000
69-30	803.750
69-37	804.625
69-40	805.000
69-42	805.250

### Group 12

Grouping 8 channels.

CH	MHz
69-01	800.125
69-05	800.625
69-11	801.375
69-25	803.125
69-28	803.500
69-36	804.500
69-41	805.125
69-43	805.375

### Group 13

Grouping 8 channels.

CH	MHz
68-03	794.375
68-13	795.625
68-18	796.250
68-26	797.250
68-37	798.625
68-40	799.000
68-44	799.500
68-46	799.750

### Group A1

Grouping 8 channels.

CH	MHz
68-06	794.750
68-20	796.500
68-24	797.000
68-40	799.000
69-04	800.500
69-17	802.125
69-23	802.875
69-47	805.875

### Group A2

Grouping 7 channels.

CH	MHz
69-11	801.375
69-22	802.750
69-30	803.750
69-36	804.500
69-40	805.000
69-43	805.375
69-45	805.625

### Group A3

Grouping 7 channels.

CH	MHz
68-10	795.250
68-21	796.625
68-29	797.625
68-35	798.375
68-39	798.875
68-42	799.250
68-44	799.500

### Group L1

Grouping 7 channels.

CH	MHz
68-09	795.125
68-11	795.375
68-19	796.375
68-25	797.125
68-30	797.750
68-34	798.250
68-37	798.625

### Group L2

Grouping 7 channels.

CH	MHz
68-10	795.250
68-13	795.625
68-17	796.125
68-22	796.750
68-28	797.500
68-36	798.500
68-38	798.750

### Group H1

Grouping 7 channels.

CH	MHz
69-09	801.125
69-11	801.375
69-19	802.375
69-25	803.125
69-30	803.750
69-34	804.250
69-37	804.625

### Group H2

Grouping 7 channels.

CH	MHz
69-10	801.250
69-13	801.625
69-17	802.125
69-22	802.750
69-28	803.500
69-36	804.500
69-38	804.750

## AC adapter for use with the URX-R1

Please prepare an AC adapter which satisfies the following conditions for normal operation of the URX-R1 Half-rack Size Diversity Tuner.

- **Specifications**

AC input voltage: Differs according to the countries.

DC output voltage: 9.0 V DC

Rated load current: more than 300 mA DC

- **The size of the DC output connector (DC jack)**

